



Goryeo Dynasty Educator Workshop

November 5, 2003

PRESENTED IN CONJUNCTION WITH THE EXHIBIT

Goryeo Dynasty: Korea's Age of Enlightenment (918 to 1392)

Asian | Education

Acknowledgments

Director of Education: Brian Hogarth
Education Resource Coordinator: Alina Collier
School Programs Coordinator: Stephanie Kao
Manager of Publications: Tom Christensen
Editorial Associate: Robin Jacobson
Graphics Specialist: Jason Jose
Photo Services Coordinator: Debra Baida
Museum Photographer: Kaz Tsuruta

Special thanks go to Kumja Paik Kim, curator of Korean art, for reviewing the contents of the packet, and Sarah Weems, education assistant.

This exhibition is made possible by support from the Korea Foundation, the Koret Foundation, and the National Endowment for the Arts. Additional support is provided by an indemnity from the Federal Council on the Arts and the Humanities. Generously sponsored by Samsung and United Airlines.

The Asian Art Museum would like to thank the following foundations and corporations for their generous grants. Educational programs and activities (primary support): The Freeman Foundation and the Wells Fargo Foundation. Educational programs and activities (ongoing support): The William Randolph Hearst Foundation Educational Endowment, AEGON Transamerica Foundation, Stanley S. Langendorf Foundation, and the Joseph R. McMicking Foundation.

Cover: The Bodhisattva Avalokiteshvara, 1310. Hanging scroll, ink, gold, and colors on silk. *Kagami Shrine, Saga Prefecture, Japan.*

Table of Contents

Exhibition Introduction	3
Aspects of Goryeo Society	12
Goryeo Buddhism	15
Recognizing Goryeo Buddhist Figures	19
Slides and Slide Descriptions	21
Lesson Plans and Activities	36
Bibliography	50
Timeline	52
Map of Korea	54



Exhibition Introduction

Goryeo Dynasty: Korea's Age of Enlightenment

Exhibition Introduction

By Dr. Kumja Paik Kim

Few people are aware that the name *Korea* is derived from the name Goryeo in Goryeo dynasty (918–1392), the focus of the exhibition now on view and of this workshop. It was during this period that Korea became known to the world outside East Asia through Western travelers to China and through West Asian merchants who came to Korea.

In the minds of connoisseurs and students of Korean art the term *Goryeo* immediately evokes images of famed celadons from the era, which were admired for their lustrous glaze and simple and elegant forms. Goryeo celadons had been among the most treasured things in East Asia, and they have been called the “first under the heaven” and their beauty compared to “the radiance of jade and the clarity of water.” One might well ask: What else was produced during this period known for the most prized celadons in the world? This exhibition thus aims to explore not only Goryeo ceramics, but also Buddhist paintings, illuminated sutras (Buddhist manuscripts), sculpture, lacquer, and metal crafts made during the Goryeo dynasty, all of which have received little attention in the West.

Under the patronage of the royal court, the aristocracy, and the Buddhist elite—whose taste for luxury and refinement was unprecedented in the history of Korea—spectacular achievements were made in all areas of the arts during this period. For many works now residing in Korea and Japan this is their first outing to the Western world; it is also the first time these works from thirty-five institutions and collections have shared the same space.

BUDDHIST PAINTING

The twenty-four paintings included in this exhibition are representations of the buddhas Amitabha (Korean: Amita) and Vairochana (Korean: Birojana); the bodhisattvas Avalokiteshvara (Korean: Gwaneum) and Kshitigarbha (Korean: Jijang); the Buddhist deity Marici (Korean: Mariji); and the Buddhist disciple Arhat (Korean: Nahan), reflecting the subjects available in extant paintings (there was originally a wider range of subjects). This selection shows the strong influence that Buddhist scriptures such as the Flower Garland Sutra (Sanskrit: Avatamsaka Sutra; Korean: Hwaeum-gyeong) and the Lotus Sutra (Sanskrit: Sadharma Pundarika Sutra; Korean: Myobeop Yeonghwa-gyeong) must have had in Goryeo society, and the strong belief of Goryeo people in their own salvation and that of others and of the nation through the merciful power of buddhas.

Goryeo Buddhist paintings were often commissioned as prayers or offerings by members of the royal family, the aristocracy, and Buddhist institutions, as in the case of the Avalokiteshvara painting in Kagami Shrine in Saga Prefecture, Japan. According to the inscription, the painting was commissioned by Queen Sukbi in 1310. Since it is known that King Chungseon (1308–1313) spent more time in Yuan China than in Korea even during his reign, the painting might represent Queen Sukbi's fervent prayer for the welfare of the king and the nation.

Many Goryeo Buddhist paintings had royal or aristocratic sponsorship and were painted by the best-trained court or monastic painters. The brush lines of utmost delicacy and the rich and intricate designs and patterns present in extant Goryeo Buddhist paintings would not have been possible without superbly trained painters. The complex textile designs and patterns and especially the diaphanous shawls imbued with an ethereal feeling could have been created only by hands that had total command of brush and col-

ors. Since the mastery of technical skills in art, unlike in some kinds of technology, never guarantees the creation of a masterpiece, Goryeo Buddhist painters must also have possessed the special inspiration needed to give birth to great works. Additionally they must have had strong faith in the power of buddhas and bodhisattvas. Without their religious conviction, it would not have been possible for them to capture the expression of intense spirituality that still moves today's viewers.

All indications suggest that Avalokiteshvara was the most favored deity during the Goryeo dynasty. Although Gwanse-eum bosal is Avalokiteshvara's full name in Korean, this deity is better known by his abbreviated name Gwaneum bosal (*bosal* is the Korean word for *bodhisattva*) or Gwaneum. His compassionate nature is fully described in the Buddhist scriptures of the Flower Garland Sutra and Lotus Sutra, both of which of all the Buddhist sutras had the greatest impact in Korea. In the Flower Garland Sutra Avalokiteshvara is described as residing in the rocky island of Potalaka in the South Seas and as preaching to help all sentient beings rid themselves of fears and attain salvation. His compassion is so great that he changes into thirty-three forms to save those in need. He is often painted unaccompanied and sometimes with the Buddha Amitabha. In this context Avalokiteshvara not only helps all living beings achieve salvation but also receives the souls of Buddhists reborn into Amitabha's Pure Land paradise.

The popularity and veneration of Avalokiteshvara in Korea, which began as early as the sixth century, are closely linked to the legends of famous Korean monks' encounters with the deity. Of the many legends two stand out: The most famous has to do with Uisang (625–702), the eminent monk of the Silla kingdom and the founder of Hwaeum-jong, the Huayin school of Buddhism. Uisang, wanting to meet Gwaneum in person, made a pilgrimage to Yangyang in Gangwon province along the central coast of the Eastern Sea (what Koreans called the Sea of Japan). On the seventh day of his prayer in a cave there, he received a string of crystal prayer beads from heaven and a magic pearl from the dragon king. After another seven days of prayers he was able to see Gwaneum, who instructed him to build a Buddhist temple at a site where bamboo grew. He named the temple Naksan-sa Monastery and enshrined within the temple the image of Gwaneum, the string of crystal beads, and the magic pearl. The second story that is important in understanding Goryeo paintings of this deity is the legend of Yu Ja-ryang. In 1185, when Yu was burning an offering of incense and worshiping at the Gwaneum cave at the Naksan-sa Monastery, a blue bird flew over him and dropped on his hat the flower it held in its beak.

Although motifs such as the rocky cliff, the bamboo, and the blue bird were also used in Chinese paintings of this deity, because of the aforementioned legends in Korea these motifs are considered typically Goryeo. Images of Avalokiteshvara that include these motifs are often called Water-Moon Avalokiteshvara (Suwol Gwaneum). As with the five Avalokiteshvara paintings that are included in this exhibition, this deity appears to have been represented following an established scheme. This indicates that although painters might have had freedom in their interpretation of minor aspects in Buddhist paintings, the iconographic canon had to be followed closely in order to make them effective.

In spite of having to adhere to the traditional Mahayana Buddhist iconography introduced to Korea from China, Goryeo painters managed to elevate Goryeo Buddhist paintings to the highest level of artistic achievement. More importantly, Goryeo painters introduced significant innovations into Buddhist painting, distinguishing their works from those by other East Asian painters. According to scholar Ide Seinosuke, Goryeo innovations can be observed in such iconographic motifs as the combined use of two sacred marks—the wheel of the Doctrine (Sanskrit: *chakra*) symbolizing the preaching of Buddha's Law and the auspicious swastika (Sanskrit: *shrivatsa*)—on the Buddha's body; medallions with floral scrolls in gold lines; and the bodhisattva Mahasthamaprapta (Korean: Daeseji) with a jade seal; as well as in new themes such as the Buddha Amitabha and the eight great bodhisattvas, and Amitabha's welcoming descent.

Goryeo Buddhist paintings also provide us with a passage to understanding the court style of Goryeo secular painting since there is a strong likelihood that religious paintings were sponsored by patrons who also commissioned secular paintings, and that the court painters who created Buddhist paintings also produced secular paintings on commission. Because only a handful of secular paintings have survived, including two small paintings in Korea attributed to King Gongmin (reigned 1351–1374), these religious paintings can be used as a guide to understanding the color schemes of Goryeo secular paintings, as well as the figure, bird-and-flower, and landscape painting styles preferred by the court.

ILLUMINATED AND PRINTED SUTRAS (BUDDHIST MANUSCRIPTS)

Closely related to Goryeo Buddhist paintings in terms of patronage, functions, and artists are illuminated sutras. Judging from extant Goryeo illuminated sutras, the most popular Buddhist scriptures were the Flower Garland Sutra, Lotus Sutra, and Diamond Sutra (Korean: Geumgang-geyong; Sanskrit: Vajracchedika prajaparamita). This exhibition includes eleven illuminated and four printed sutras, along with one example of a Goryeo woodblock.

The full flowering of manuscript illumination during the Goryeo dynasty appears to have been made possible by the development of advanced printing techniques in Korea during this time. Especially famous are the monumental projects of carving woodblocks containing the complete set of Buddhist canon, Tripitaka (sutras, laws, and treatises)—not just once but twice. The first set, which was burned during the Mongol invasion in 1232, had been completed in 1087 for the purpose of expelling the invading Khitans through prayers to buddhas. The second set, known today as Tripitaka Koreana, was completed in 1251 as an aid to pray for the power of the buddhas to protect the nation from the invading Mongols. The second Tripitaka set, containing more than eighty thousand woodblocks, is now housed in the repository in Haeinsa Monastery near Daegu. Goryeo is also credited with inventing a form of movable metal type in the first half of the thirteenth century in order to meet heavy demands for various types of books, both religious and secular. *Prescribed Ritual Texts of the Past and Present (Sangjong Gogeu Yemun)*, was printed by Goryeo artisans in 1234 using a system of movable metal type that predated the one invented by the German printer Johannes Gutenberg by more than a century.

Because books and sutras printed with woodblocks and movable metal type served the purposes of educating the elite and monks as well as propagating Buddhism, luxurious editions of illuminated sutras were commissioned for special occasions. As was the case with the Assembly of the Appearance of Light Sutra (Korean: Daebojeok-geyong; Sanskrit: Maharatnakuta Sutra) dated 1006 (no. 28), which was commissioned by the mother of King Mokjong (reigned 997–1009), known as Queen Cheonchu Taehu or Queen Heonae (964–1029), together with the powerful Gim Chi-yang (died 1009), many illuminated sutras were commissioned by the royal family, wealthy aristocratic families, or powerful Buddhist monks. Sutras were commissioned as prayers to seek the buddhas' great power on various matters, from peace and prosperity of the nation; to pray for the expulsion of foreign invaders, and for the welfare and longevity of the king; to pray for many male offspring; and to bless the living and deceased members of the royal and aristocratic families. Sutras were also commissioned to celebrate the dedication of major Buddhist temples.

To have a relatively large number of Goryeo illuminated sutras surviving and in good condition may in part be the result of the superb quality of Korean mulberry paper. This paper was already admired for its strength, thickness, glossiness, and softness during the Unified Silla period, and its popularity continued throughout the Goryeo dynasty. Although it is known that white paper was particularly valued by scholars and painters for its beauty and resiliency, the paper used for illuminated sutras was usually dyed purple, dark blue, ochre, or yellow. As with silk, dyeing paper served to repel insects. As an additional strengthening measure, Korean paper was beaten, giving both sides a shine suitable for writing and painting.

The reason extant Goryeo illuminated sutras are consistently of high quality can be found in the system of maintaining scriptoria (*geumja-won* and *eunja-won*) by the court and major temples, which employed well-trained scribes and painters who worked in gold or silver letters. Although illuminated sutras were introduced to the Goryeo court from the Song dynasty in China, by the thirteenth century the skill of Goryeo scribes had reached a height previously not seen in East Asia. At the request of the Chinese Yuan dynasty court, the Goryeo court sent to China illuminated sutras in gold and silver along with a hundred scribes and painters in 1290 and another hundred scribes and painters in 1305.

The gold and silver lines representing scenes from the Flower Garland and Lotus sutras on dark blue paper create a dazzling visual effect. The thin, wirelike brush lines used in illuminating frontispiece scenes brim with taut energy and strength. The stylized gold diagonals and spirals of the drapery folds of buddhas' and bodhisattvas' garments and the abstract setting created by using parallel lines, dots, and floral petals in rich detail express the painters' devotion to Buddhism and spiritually transport viewers from this world to the wondrous world of buddhas and bodhisattvas. Each illuminated sutra is the joint product of a scribe, a painter, and a patron or patrons, all of whom were devoutly religious, had complete faith in Buddha's power of salvation, and were confident that their project would bear fruit. The artistic mastery and deep religious conviction of the painters went hand in hand in creating illuminated sutras of unchallenged beauty and religious intensity.

BUDDHIST SCULPTURE

Goryeo Buddhist sculpture has received little attention in comparison to Buddhist sculpture of the preceding Unified Silla period, which has been made famous by the magnificent seated Buddha and surrounding relief images of bodhisattvas and arhats, as well as other guardian figures from the Seokkuram grotto in Gyeongju. In the early part of the Goryeo dynasty the stylistic tradition established during the preceding Unified Silla continued. Iron and granite continued to be favored. Judging from extant iron images, the earlier tradition was carried on in scale as well as in the use of the piece-mold method. Though not represented in this exhibition, which includes nine sculptural images, granite, the most abundant sculptural material in Korea, remained a favored medium.

It appears that Goryeo's relationship with China is most apparent in Buddhist sculpture. The influence of the Northern Song Dynasty (960-1279) as well as the three independent dynasties (907-1278) that ruled northern China during the Southern Song dynasty, was felt in Goryeo Buddhist sculpture throughout the middle and late Goryeo period. China's influence on Korea became most prominent during the Yuan dynasty (1279-1368)—when Mongol princesses were the wives of the Goryeo kings from King Chungyeol (reigned 1274-1308)—and continued through its fall. The daughter of Khubilai Khan, known in Korea as Jeguk-daejang gongju, brought a retinue of Mongols to serve her in the Goryeo court. Many Buddhist images made in Korea, especially in gilded bronze, from the late thirteenth century through the end of the fourteenth century show a strong stylistic influence of Tibetan and Nepalese Buddhist sculpture. The small gilded bronze seated Mahasthamaprapta (Korean: Daeseji bosal) in the collection of Horim Museum (no. 46) is a good example, reflecting the close stylistic connection between late Goryeo and Yuan works, and showing the influence of Tibetan international style.

LACQUER WARES

There are only about fifteen known Goryeo inlaid lacquer objects in the world, and this exhibition includes four of them. Since the Three Kingdoms period (57 BCE-668 CE) there had been a bureau responsible for taking care of things connected to lacquer, from overseeing the care of lacquer trees to extracting and refin-

ing sap obtained from them to producing lacquer objects. During the Joseon dynasty (1392–1910) the central government had a system in which they counted the lacquer trees every three years, keeping a careful record of their numbers. It can be assumed this was a tradition that had come down from earlier times, including the Goryeo period.

It appears that the special inlay technique for which Goryeo became famous had been perfected by the eleventh century, since King Munjong (reigned 1046–1083) sent inlaid lacquer objects as gifts to the Liao court, which ruled northern China. The distinct qualities of Goryeo inlaid lacquer works were described by the Chinese as “intricate and precious” and “extremely elegant.” The technical mastery, the availability of lacquer artisans, and the widespread production of Goryeo inlaid lacquer objects can be attributed to the establishment in 1272 of a temporary bureau called Jeonham Joseong Dogam for the production of inlaid lacquer sutra boxes specifically to house the Tripitaka, the complete collection of Buddhist canon. This collection was commissioned by the Mongol court of the Yuan dynasty, which ruled China from 1279 to 1368. The rectangular box with cover in this exhibition (no. 53) might have been one of the sutra boxes made for this purpose.

What made Goryeo lacquer wares especially outstanding was the ingenious technique of decorating the surfaces of the lacquer objects with designs inlaid with minute mother-of-pearl and tortoiseshell pieces; the combination of these two materials is characteristic of Goryeo inlaid lacquer works. These intricate designs were created by assembling numerous pieces of mother-of-pearl and tortoiseshell cut to minute sizes, which were never larger than about two-fifths of an inch. Mother-of-pearl pieces came from abalone shells; their iridescent quality was used to create dazzling effects. Tortoiseshell pieces were frequently painted on the back in red or yellow. These bright colors enhanced the gemlike quality of the objects. The tiny mother-of-pearl and tortoiseshell pieces, like tesserae in Roman mosaics, did not function independently, but formed parts of the overall design, such as a leaf of a branch or a petal of a flower.

Another characteristic feature of Goryeo inlay lacquer technique is the use of single- or double-twisted wire lines made of silver or copper alloy. These wire lines functioned as branches for leaves, stems for floral scrolls, borders separating decorative panels, or outlines emphasizing important motifs.

The intricate and dazzling designs created by hundreds of tiny pieces of iridescent mother-of-pearl, highlighted by tortoiseshell pieces painted in reverse and strengthened by silver or copper wire lines, made Goryeo inlaid lacquer objects shimmer in rainbow colors. Inlaid lacquer works such as the round box from Taima-dera temple (no. 50) dazzle today’s viewers as they did the twelfth-century Chinese scholar-official Xu Jing, who recorded his impressions for the Chinese court.

METAL CRAFTS

In contrast to its selection of paintings, sutras, and lacquer wares, all of which were made exclusively to serve religious purposes, the twenty-three Goryeo metal crafts in this exhibition include both religious and secular objects. Religious objects included in this exhibition are temple bells, a gong, a ritual bell (*vajra*), ritual sprinklers (*kundika*), reliquaries, incense burners (*hyangwan* or *hyangno*), a portable shrine, and a miniature pagoda, while secular objects include covered boxes, a ewer with a bowl, a basin, a mirror stand, a bottle, and a bracelet.

Because Buddhism remained a state religion, as in the previous dynasty, large numbers of temple bells (*beomjong*) were cast during the Goryeo dynasty. Although they were not as large as bells from the Unified Silla dynasty had been, they served the same function, telling the time each morning and evening, and call-

ing out important ceremonial assemblies. The sound of the major temple bells also served the function of spreading the message of the Buddha through their far-reaching resonance. Since there is no clapper in Buddhist temple bells, sound is produced by hitting the side of the bell with a large wooden pole that hangs from a rope.

While Buddhist temple bells announced the time of the day, temple gongs (*banja* or *geumgo*) such as the one from the Ho-Am Art Museum (no. 58) announced meal and assembly times. Among extant temple gongs, about forty are inscribed with the year in which they were made. Like the Ho-Am gong (dated 1218), most of them date from the first half of the thirteenth century. They all have the appearance of a shallow basin. Two rings are attached on the side for hanging. The surface decoration usually consists of the lotus seeds in the center, lotus petals in the first circular band, and floral scrolls in the outermost band.

The most noteworthy Goryeo metal objects made to serve religious purposes are those with designs in silver inlay (*ipsa*). The technique of inlaying metal crafts appears to have been flourishing in the region of Gaya in the fourth and fifth centuries (Three Kingdoms period, 57 BCE–668 CE). The technique of this era subsequently influenced that used in Goryeo lacquer and ceramics. Incense burners and ritual sprinklers used in Buddhist temples were often inlaid in silver. Incense burners, which occupied a prominent spot on the Buddhist altar, had the shape of bowls with tall stands, a form prevalent in stonewares dating from the fourth century.

Kundika are Buddhist ritual vessels originating in India and introduced to Korea from China. They were used to offer purified water to the Buddhas. During the Goryeo period, this form was made both in bronze and ceramics.

Goryeo people used metal utensils more commonly than they did celadon ceramics, which they apparently regarded as more precious. Considering that even today Koreans use more metal utensils than do other East Asians, techniques for making metal crafts for secular purposes must have made great strides. Everyday objects such as the gilded silver mirror stand topped with a relief lotus and phoenix finial and decorated with floral chrysanthemum scrolls (no. 74), the large water basin inlaid in silver with arabesque and dragon designs (no. 73), and the small gourd-shaped gilded silver bottle decorated with floral and phoenix designs in repoussé (no. 76) exemplify the luxurious lifestyle enjoyed by the royal and aristocratic members of Goryeo society.

The ewer and bowl set belonging to the Museum of Fine Arts, Boston (no. 72), gives a glimpse of the highly developed metal crafts of this period. The body of the ewer is fluted, imitating bundles of half-split thin bamboo. The metal bends at a sharp angle, forming a foliated line at the top of the body into a flat shoulder. The fluting continues onto the neck. The lid is in the shape of two luxurious lotus flowers with a phoenix on the very top. The elegant bowl reflects the fluting design of the ewer. Together they testify to the height of refinement and elegance reached in Goryeo metal crafts.

CERAMICS

Goryeo ceramics have become synonymous with celadons. Goryeo celadons are stonewares with a blue-green glaze called *cheongja*. Their beginnings date to the late ninth century, and they reached their pinnacle during the first half of the twelfth century. To meet the standards demanded by their patrons, Goryeo potters created the most exquisite of celadons, which have been held in the highest esteem since the early twelfth century.

According to scholar Margaret Medley, dramatic technological advancement was made in ceramics in both China and Korea during the tenth and eleventh centuries. But in originality and technical development Korea's advances were the more impressive and rapid. Celadon production in Korea was initially inspired by Chinese yue ware, whose even olive-green glaze fascinated Korean potters during the late Unified Silla and early Goryeo periods. Subsequently, Chinese ceramics such as *ding*, *yaozhou*, *chingbai*, *ru*, and *cizhou* wares provided further inspiration and challenge for the Goryeo potters in their search for superior decorative techniques and jade-like glazes.

In 1123 a young Chinese scholar named Xu Jing (1091–1153) came with a Chinese embassy from Northern Song Huizong emperor's court to the court of King Injong (reigned 1122–1146). He made a careful record of his observations and experiences in Korea in his report entitled *Illustrated Record of the Chinese Embassy to the Goryeo Court during the Xuanhe Era (Xuanhe fengshi Gaoli tujing)*. In the chapter dealing with utensils he praised the beauty of the jade-colored glaze and the novel forms of Goryeo celadon. He wrote that the Koreans referred to their celadon wares as jade-colored (*feise*) and that in the preceding years the production of celadon had become quite skillful, resulting in outstanding colors. He was particularly impressed with the jade-colored incense burner with a lid carved in the shape of a crouching lion, which he considered the most excellent piece among the various ceramic vessels. He also thought the colors of other celadon were very similar to the old "secret color" (*mise*) of yue wares and the new ru wares.

In the above comment made by Xu Jing on Goryeo celadons we can observe a couple of significant points. The phrase "secret color" referred to the deep blue-green color of the yue ware, which was produced in China during the ninth and tenth century for the exclusive use of the imperial family. Xu's remark about the ru ware being new suggests that the famous Northern Song dynasty imperial ware prized by Chinese connoisseurs for its beauty and rarity had not been in production long before 1123, making it approximately concurrent with the best Goryeo celadon he saw in Korea.

It is thought that with the exception of some ru wares, Goryeo celadons of the early twelfth century surpassed Chinese celadons in the beauty of the glaze, form, and style. Only about sixty-four Chinese imperial ru wares have survived, while most museums in the world that include East Asian art have a substantial number of excellent Goryeo celadons in their collections. It appears, therefore, that not just in quality but also in quantity Goryeo celadon far outperformed Chinese imperial ru wares.

The beauty of Goryeo celadons is derived from the combination of three elements: form, decoration, and glaze. Their forms range from extremely simple to complex and sculptural. Their decorations vary from undecorated (*somum*) to decorated with incised (*eumgak*), carved (*yanggak*), mold-impressed (*hyeong-ap*), and openwork (*tugak*) designs. Goryeo carved designs are especially vigorous and strong. Goryeo mold-impressed designs (no. 83) show crisper impressions than similar works from China, due perhaps to the fact that with Goryeo celadons a single mold was used to produce fewer pieces than with their Chinese counterparts. But the most determining of the three elements may be the lustrous celadon glazes, whose hues range from gray-green and gray-blue to blue-green and green-blue.

Sometime during the second quarter of the twelfth century, Goryeo potters made two significant advances in decorating celadons. First is perfecting the inlay technique (*sanggam*) and second is incorporating underglaze copper-oxide (*jinsa*). The inlay technique had been used in Korea for many centuries in metal crafts and lacquer wares. Goryeo potters carved designs on the leather-hard surfaces of their ceramic forms and brushed on white or red slip. In order for the white and red slip to tightly merge with the clay body, slip-decorated ceramic forms received the first firing in an oxidizing atmosphere. When they were cooled, the

glaze was applied, and they received the second firing in a reducing atmosphere. During the second firing, the areas decorated with white slip remained white while those with red slip turned black.

Goryeo potters were the first to use copper oxide under the celadon glaze. It is believed that the earliest method was covering the form completely with copper oxide. The second method was painting, as seen in the bowl in the collection of the British Museum (no. 104). The last method involved using small drops of copper oxide over the areas already decorated with white slip, which enhanced the red color of copper oxide.



Aspects of Goryeo Society

Aspects of Goryeo Society

By Brian Hogarth

THE FORMATION OF GORYEO RULE

Goryeo emerged from the disintegrating Unified Silla kingdom. The new dynasty was founded by a northern general, Wang Geon (posthumously known as Taejo). He renamed the state Goryeo, from which the modern name Korea is derived.

Wang Geon moved the capital north to Gaegyong (modern-day Gaeseong in North Korea). By securing a northern capital, he signaled the start of a distinct, new regime. He also saw Goryeo as a restoration of one of the old Three Kingdoms—Goguryeo (37 BCE–668 CE) and the reestablishment of its northern boundaries.

The process of consolidating the new kingdom lasted about a decade. The last Silla king formally surrendered in 935, and the following year, neighboring Baekche fell under Goryeo control. To hasten the process of national unity, Wang Geon established marriage ties with more than twenty regional families. He also welcomed to the capital leading families of the Parhae kingdom to the north, who were retreating from the advancing Qidan peoples to the northwest. (Qidan peoples founded the Liao dynasty in northern China.)

The period immediately following Wang Geon's reign was rather unstable, and it wasn't until the reign of King Gwangjong (949–975) that the new royal authority was firmly established.

GORYEO POPULATION AND SOCIAL CLASSES

In the twelfth century, in the middle of the Goryeo dynasty, it is believed that the population reached about 3 million people, of which 500,000 lived in the capital.

The aristocracy made up about six percent of the population. Aristocratic families were defined by lineage and by local affiliation. Their social status was inherited, and their income was derived mainly from revenues from the produce of their lands. Goryeo society was an agrarian one, with most of the burden falling on the peasant classes. Peasants paid about a quarter of their harvest to the state, and half to their aristocratic landlords. They were also subject to *corvée* labor, such as being called to work on large public construction projects without pay.

Below the peasants were artisans and merchants. Merchants were considered even lower than artisans since they only traded in other people's merchandise, whereas artisans produced tangible objects. Slaves—the "lowborn"—comprised the bottom layer of society. They could be bought and sold, and were ineligible for social mobility.

Goryeo society enjoyed periods of relative prosperity between the end of the Qidan invasions (993–1018) and the military takeovers beginning in 1170. While Goryeo remained by and large a hereditary aristocracy, it nevertheless advanced the potential for increased social mobility and reform.

SOCIAL MOBILITY AND POWER

The greatest potential for social mobility lay either in the successful completion of the new civil service examinations, leading to a government appointment of some kind, or in meritorious actions in military

service, leading to advancement in rank. If one assumed a higher status, that status could be inherited by one's offspring.

Several reforms were carried out during King Gwanjong's reign concerning social inequality and mobility. The first concerned slavery. Many prisoners and refugees had been forced into slavery in the turmoil of the preceding decades. A new Slave Review Act redressed some of these problems, although it did not change the status of the hereditary slave class.

Another reform concerned education and government service. In 958, civil service examinations were introduced that, in theory at least, allowed civilians to compete for official positions normally reserved for the elite military and aristocratic families. This was essentially the same type of examination system adopted in China, being based on knowledge of the Confucian classics. The adoption of this system helped to develop a new government bureaucratic structure in Korea. Confucianism offered a political ideology that helped to consolidate the government's authority over the various regional gentry, whose factionalism had contributed to the breakdown of the former Silla kingdom. The examination system seemed to offer the possibility of advancement for ambitious individuals while placing a check on aristocratic privilege. In reality, the aristocratic families maintained the advantage, since they could afford to properly prepare their youth for the examinations.

In the Silla kingdom, ruling clans had consolidated their positions in government through a "bone rank" (based on hereditary bloodline) system of lineage. Goryeo changed this system by dispatching government officials from the capitals to the various provinces to head local administrative units. In turn, provincial gentry were actively recruited for positions in the capital, thus consolidating power in the central government. Aristocratic families sought whatever means they could to advance their power at the court. One of the best ways to do this was through marriage. The ideal was to marry your way into the innermost court circles—best of all, to be married to a member of the king's family. The upper echelons of Goryeo society therefore jockeyed for position around the king. At various times, a handful of families dominated court life. During periods of succession, there was always the danger of becoming associated with the wrong family. Opponents of a new king could suddenly be exiled or purged.

FOREIGN OBSERVATIONS

While we do not know much about Goryeo society from direct sources other than the official *Goryeo sa* (history of Goryeo), there are interesting writings by the Chinese emissary Xu Jing (1091–1193), who traveled to Goryeo from Song dynasty China in 1123. He observed how confident and expressive the people of Goryeo were, and yet how different they were from the Chinese. Here is one extract:

"Although the Goryeo territory is not expansive, there are many people living there. Among the four classes of people, Confucian scholars are considered the highest. In that country, it is considered shameful not to be able to read. There are many mountains and forests, but because there is not much flat land, their skill at farming has not developed as much as their craftsmanship. As the products of the countryside are all committed to the state, merchants do not travel widely. Only in the daytime do they go to city markets and exchange what they have for what they do not have. Although the people are prosperous, the favors they extend, however, are few. As they are lascivious, they love freely and value wealth. Men and women take marriage lightly and divorce easily. They do not follow proper ritual, which is deplorable."

(Trans. from Lee and de Bary, eds., *Sources of Korean Tradition*)



Goryeo Buddhism

Goryeo Buddhism

By Brian Hogarth

Korea's Goryeo dynasty presided over an enlightened Buddhist state. People at all levels of Goryeo society—both rulers and subjects—were ardent believers in Buddhism and looked to their faith to help guide their souls and their nation through troubled times. In this time of great faith, politics and religion were intertwined, and religious convictions were expressed in personal ways and through public ceremonies and rituals. In this section, we explore some of the dimensions of Buddhism during the Goryeo dynasty.

THE DEVELOPMENT OF KOREAN BUDDHISM

Buddhism was introduced to Korea from China in the fourth century, at a time when Korea was divided into several kingdoms. Buddhism served two main interests. For the ruling class, it represented a sophisticated model of statecraft, with universal deities acting as protectors of the state. Kings acted as beneficent monarchs with the consent and advice of spiritual leaders. For the masses, Buddhism addressed the more immediate concerns of health, offspring, ancestors, nature, and the spirit world.

When Korea was unified under the Silla kingdom in 668 CE, Buddhism was adopted as the official state religion, after some initial resistance from the ruling clans. The Silla and the subsequent Goryeo dynasty represent the high watermarks of Korean Buddhism.

Korean Buddhism was adapted from Chinese forms of Buddhism. Chinese Buddhism had come from India primarily via Central Asia. By the time of the Silla, Chinese Buddhism had already evolved into numerous branches emphasizing different Buddhist texts and practices. There was a natural tendency for Korean monks to sift through these many schools looking for common denominators. This was especially true during the Goryeo dynasty, when concerns about Korean national unity and security made such principles even more appealing.

Early Goryeo Buddhism was centered on two schools: Gyo (Doctrine) which stressed the study of particular Buddhist texts, and Seon (Meditation) which emphasized insight based on the practice of meditation. Uicheon (1055–1101), one of the sons of King Seongjong (mentioned below), studied in China and introduced the Cheontai sect (Chinese: Tiantai) as an attempt to balance doctrinal study with meditation. A later monk, Jinul (1158–1210), unified the ten branches of Seon, and formed the foundations of the popular Jogye sect, which is now the largest branch of Buddhism in Korea. Jinul's most famous doctrine is that of "sudden enlightenment followed by gradual practice." He renounced worldly fame and established the idea that meditation practice was best carried on in seclusion. One of the temples he founded—Songgwangsa—survives as the main center for meditation study in Korea.

ROYAL AND ARISTOCRATIC SUPPORT OF BUDDHISM

When Wang Geon founded the Goryeo dynasty in 918 CE, he sought to restore unity to a country that had been divided by regional factions. From his new capital at Gaegyeong (present-day Gaesong in North Korea) he immediately set about the construction of ten new monasteries. In his famous "Ten Injunctions," a set of guidelines for the future operation of the state, he emphasized that "the success of every great undertaking of our state depends upon the favor and protection of the Buddha." He also attributed his success to the powers of geomancy and shamanism to protect the state and new capital. Under his new regime, Buddhism was brought under more centralized government control. The Royal Preceptor (a newly created position) was responsible for overseeing religious sects and guiding the nation on a spiritual level.

Goryeo royalty commissioned the construction of temples and pagodas and the production of illuminated texts and paintings. About seventy temples were built in the capital alone. Goryeo kings sponsored large public festivals that included grand processions, and the feeding of thousands of monks. At other festivals, sutras were read atop tall towers and prayers offered for the benefit of the state. Cattle were set free and fishing nets burned in observance of the Buddhist proscription against eating meat.

The aristocracy donated properties for Buddhist use. Monasteries were tax free and grew rich from raising and selling such commodities such as tea, rice, and livestock. Monasteries even formed their own militias. Monks sometimes became politically powerful, and families often sent one of their sons to become monks. Monasteries also served as local hospitals and oversaw cremations and other life passage rituals in their communities. Thus, Buddhist institutions became the cornerstone of Goryeo society.

During the reign of King Seongjong (981–997) Buddhism was briefly suppressed in favor of Confucianism, but after that a succession of kings reaffirmed the state's commitment to Buddhism. For example, King Munjong (1046–1083) oversaw the construction of a new monastery, donated a gold- and silver-covered pagoda to another monastery, initiated a series of public lectures on Buddhism, ensured the swift punishment of monks who abused their position, upheld the annual "Ceremony of Chanting Sutras," took pilgrimages during which thirty thousand lanterns were strewn along the highway, received delegations from Japan that included gifts of Buddhist images, donated a Flower Garland Sutra (Korean: Hwaem-gyeong; Sanskrit: Avatamsaka Sutra) written in gold over blue paper, personally took the bodhisattva vows, and enlisted one of his sons to personally escort a complete set of Buddhist texts from the Northern Song court in China. Another of his sons (Uicheon) became a future National Preceptor.

PROTECTING THE NATION

Royal support of Buddhism was not simply a display of pomp and vanity. It was undertaken in part to protect the nation from foreign invasion. During King Seongjong's reign, the Qidan peoples to the north began a series of attacks that lasted three decades. Initially repulsed, they attacked again in 1010 and briefly overran the capital. Only in 1018 were they defeated. A century later, the new Jin dynasty of northern China threatened Korea again. The Goryeo dynasty found it difficult to negotiate satisfactory relations with both the Jin and Southern Song dynasties. Traditionally, the greater or more powerful nation could demand tribute from the lesser neighboring kingdoms. The Goryeo court's preference was for continued relations with Song China, but they had to negotiate peace with their northern neighbors. Gradually, this state of confusion caused factional disputes and revolts to break out. In 1170, disgruntled generals fought for control, and one established a military dictatorship that lasted from 1197 until 1258. During this time, monks were engaged in active military service. A group of enlisted monks attempted to assassinate one of the military rulers but failed. About eight hundred monks were killed in retaliation.

The final threat came from the Mongols, who overran northern China, including the Jin state, in 1215. The Goryeo dynasty negotiated peace, but it was short lived. The first Mongol attack came in 1231. The next year, the court retreated to Kanghwa Island, leaving the general populace to bear the brunt of the Mongol invasions. In 1270 the Korean court sued for peace and returned to the capital. A century of Mongol domination followed. Korean crown princes and young women were sent to the Mongol court. Goryeo kings married Mongol princesses. Koreans were forced to participate in two (unsuccessful) invasions of Japan. The Goryeo dynasty never fully recovered from the damage inflicted by the Mongols.

Yet support for the Buddhist establishment never abated. Buddhism was seen as a force to help unify and bolster the people. It was felt that meritorious acts on a massive scale could benefit the whole nation. The

most famous example is the commissioning of two sets of the complete Buddhist texts, a project that involved carving more than eighty thousand woodblocks each time. The first set—completed in 1087—was destroyed by the Mongols. A second set was completed in 1251, while the court was in exile. It was later moved to Heinsa monastery, where it survives to this day.

DECLINE OF GORYEO BUDDHISM

A century of foreign domination and hardship weakened the resolve of the Goryeo dynasty and the ability of its institutions to guide the nation. Late Goryeo Buddhism was increasingly accused by segments of the government of contributing to the corruption of the state. Monasteries were seen as rich and corrupt. Monks flocked to the orders to escape paying taxes. Increasingly vocal Confucian scholars argued that the king's attention was too focused on the hereafter instead of on present conditions. There were calls for a return to more strict forms of morality. These initiatives would become fully realized in the succeeding Joseon dynasty. At that time, Buddhism fell out of favor and was suppressed.



Recognizing Goryeo
Buddhist Figures

Recognizing Goryeo Buddhist Figures

By Brian Hogarth

In general, Buddhist figures can be identified by such indicators as what they wear or hold, the arrangement of their hair, and the positions of their hands and bodies. Goryeo Buddhist artists drew on Chinese models and artistic conventions, but also developed unique characteristics for their figures. Painted images are rendered with very delicate brushwork. Bodhisattvas are richly clad with multiple layers of garments, and are adorned with brooches, anklets, bracelets, armbands, and earrings. Transparent shawls give the figures a mysterious, airy quality. Sculptures are traditionally decorated with color, lacquer, pigment, or gilding.

Among the most prominent figures in Goryeo Buddhist art are the following buddha and bodhisattva figures:

Shakyamuni (Korean: Seokkamoni), the historical Buddha of our own age, shown touching the earth, indicating the moment of enlightenment. A key figure in main image halls of Buddhist monasteries.

Vairochana (Korean: Birojana), a metaphysical or universal buddha who encompasses all worlds. He is shown with the unique “diamond fist” gesture (the index finger of the left hand grasped by the other hand). He is associated with the Hwaeum sect based on the Flower Garland Sutra (Korean: Hwaeumgyeong; Sanskrit: Avatamsaka Sutra; see below). A key figure in main image halls of Buddhist monasteries.

Amitabha (Korean: Amita), a buddha who presides over the Western Paradise, into which devoted worshippers hope to be reborn. He is shown preaching or welcoming souls into his Pure Land. A key figure in halls devoted to Amitabha in Buddhist monasteries.

Mahasthamaprapta (Korean: Daeseji), literally “he who has obtained great power”; this bodhisattva opens people’s eyes to awakening. He is paired with the bodhisattva Avalokiteshvara when accompanying Amitabha or Shakyamuni. He typically holds a seal or lotus bud.

Avalokiteshvara (Korean: Gwaneum), the most popular bodhisattva figure, one who hears the sufferings of humanity, and can appear in thirty-three manifestations. He bears an image of Amitabha in his crown, carries a willow branch and a water sprinkler (*kundika*) and is often seen in “water moon” form, contemplating the moon’s reflection in the water off the island where he resides. He can appear alongside Amitabha or separately.

Kshitigarbha (Korean: Jijang), another bodhisattva, who saves souls stuck in hell. He has a shaved head often covered with a scarf, and carries a staff with rings. He can appear in the middle of ten judges in a separate hall in Buddhist monasteries.

Arhats (Korean: Nahan) disciples of the Buddha; usually depicted as monks; in groups of as many as five hundred.



Slides and Slide Descriptions

Slides and Slide Descriptions

By Alina Collier

SLIDE 1



Seated Buddha, 1100–1300
Gilded bronze
Ho-Am Museum, Korea

WHEN DID BUDDHISM ARRIVE IN KOREA?

Buddhism arrived in Korea during the fourth century with monks from China who were carrying Buddhist images and scriptures. From the time of Buddhism's introduction in Korea, it gained the support of the rulers and the aristocracy, and it gradually spread to the general population. By the time of the Goryeo dynasty, Buddhism had become fully established.

HOW DO WE KNOW THIS IS A FIGURE OF THE BUDDHA?

Although Buddha images vary greatly from place to place, they almost always show these conventional features:

Symbols of radiance, among which may be a halo around the head or the whole body, a flame at the top of the head, and a gold-covered surface.

Superhuman physical characteristics such as very large dimensions, a lump on the top of the head (sometimes said to indicate extraordinary wisdom), fingers all the same length, and special markings on the palms and on the soles of the feet.

Long earlobes (said to have been stretched during the years when the Buddha-to-be, as a prince, wore heavy earrings).

Monk's robes, a sarong-like lower garment and one or two upper garments, each made of a sheet of cloth wrapped around the upper body, sometimes leaving the right shoulder bare.

Special body positions, the most common being seated with the legs crossed or interlocked. Symbolic hand gestures that convey special meaning.

The gilded bronze Buddha depicted here was cast in one piece and is hollow inside. His hand gesture, with the right hand palm raised, symbolizes the dispelling of fear. This kind of Buddhist sculpture would have been used for private worship or placed in the main hall of a monastery.

WHAT EFFECT DID BUDDHISM HAVE ON THE ARTS OF THE GORYEO DYNASTY?

The Goryeo dynasty reached a spectacular level of intellectual and artistic achievements under the patronage of the royal court, the aristocracy, and the Buddhist elite. The fervor for Buddhism propelled the need for a large number of Buddhist related art including ritual objects made of bronze and ceramics, paintings commissioned by the royalty or aristocracy, illuminated sutras, sculptures for monasteries and altars and more.

SLIDE 2



The Buddha Amitabha flanked by two bodhisattvas, 1300–1390
Hanging scroll, ink, colors and gold on silk
Nezu Institute of Fine Arts, Japan

WHO IS AMITABHA?

Also known as the “Buddha of Infinite Light” and the “Buddha of Infinite Life,” Amitabha presides over the Western Paradise. While still a bodhisattva, Amitabha meditated for five eons (*kalpa*) and took forty-eight vows to save all suffering beings. In the eighteenth vow he promised rebirth in his paradise to any being that called upon his name in absolute faith. When souls are reborn in his paradise, they are cleansed of all impurities; thus it is also known as the Pure Land.

Amitabha was one of the most prominent figures in Goryeo dynasty painting, reflecting the influence of Pure Land Buddhism at the time. This sect began in the Unified Silla period and gained popularity among all classes, because it was believed that devotees, regardless of social status, could be reborn into the Pure Land if they recited Amitabha’s name with absolute faith.

Here Amitabha is depicted flanked by the bodhisattvas Avalokiteshvara on the right and Mahasthamaprapta on the left. On Amitabha’s chest the swastika (Sanskrit: *shrivatsa*) symbol appears, representing the light that emanates from him and illuminates the realm. On his feet the symbol of the wheel (Sanskrit: *chakra*) appears, representing the ever-turning wheel of the Doctrine, and his hands are placed in the hand gesture that symbolizes the preaching of Buddhist law.

WHY WERE PAINTINGS LIKE THIS ONE COMMISSIONED?

During the Goryeo dynasty, commissioning Buddhist paintings was believed to invoke the power of the deity and bring merit to the patron. Large paintings with a seated Amitabha were typically hung behind the main sculpture of the Buddhist altar. In Buddhist temples and monasteries, devotees stood in front of images of Amitabha and recited the phrase “Nammu Amitabul,” meaning “homage to the Buddha Amitabha.”

SLIDE 3



The Bodhisattva Avalokiteshvara, 1310
Hanging scroll, ink, gold, and colors on silk
Kagami Shrine, Saga prefecture, Japan

WHAT IS A BODHISATTVA?

A bodhisattva is an enlightened being who is destined for nirvana, but chooses to postpone his or her own buddhahood to help liberate all beings in the universe from suffering. In contrast to the simple robes in which the Buddha is depicted, bodhisattvas are often depicted wearing elaborate jewelry and flowing, almost transparent robes.

WHO IS DEPICTED HERE?

Avalokiteshvara, the Buddhist deity of compassion, was the most popular bodhisattva figure of the Goryeo dynasty. His name means “one who hears the sufferings of humanity.” It is believed that Avalokiteshvara, an attendant of Amitabha (see slide 2), can transform himself into thirty-three forms to save beings from suffering and lead them to Amitabha’s Pure Land paradise. During the tumultuous Goryeo dynasty, which was marked by several invasions, the worship of Avalokiteshvara appealed to many people because of its promise of salvation in times of danger.

His compassionate nature is described in the Flower Garland Sutra (Korean: Hwaeum-gyeong; Sanskrit: Avatamsaka Sutra; see slides 6 and 7) and Lotus Sutra (Korean: Myobeop Yeonghwa-gyeong; Sanskrit: Sadharma Pundarika Sutra), both of which had the greatest impact of all Korean Buddhist sutras. The entire twenty-fifth chapter of the Lotus Sutra is dedicated to Avalokiteshvara and his abilities to save persons from harm.

WHAT IS HAPPENING IN THIS PAINTING?

This image is considered to be one of the monuments of Goryeo dynasty painting. Here Avalokiteshvara is seated in the “royal ease” position on a rocky outcropping surrounded by water lit beautifully by moon-

light. This popular Goryeo dynasty depiction of the bodhisattva is referred to as the “Water-Moon Avalokiteshvara.” This scene is directly based upon a chapter of the Flower Garland Sutra and reflects the significance of that portion of the scripture in the Goryeo period. The chapter details the journey of a youth named Sudhana as he visits fifty-three teachers, each representing a different level of being. This image depicts Sudhana’s twenty-eighth stop on his journey as he visits Avalokiteshvara on the mythical mountain island of Potalaka. Sudhana can be seen in the lower right-hand corner of this painting.

WHY IS THIS PAINTING IMPORTANT?

This painting is one of the largest of its kind in all of East Asian art. There are signs that the original was even larger, and then was trimmed to its current size. The scale of this painting does not diminish its attention to detail or its delicacy of execution. The eight artists who worked on this painting applied pigment on both the back and the front of the silk. This technique helped to give the painting a luminous quality.

Avalokiteshvara is customarily depicted facing the left side of the painting. Scholars believe that the fact that this image is facing the right side of the painting indicates that this work had a special purpose.

WHO COMMISSIONED THIS PAINTING?

This painting was commissioned by Queen Sukbi around the time of the death of King Chungyeol (ruled 1274-1308). The queen’s motive for commissioning this painting is not mentioned in the inscription and is the subject of much speculation. The most popular theory is that the painting was commissioned as a prayer to Avalokiteshvara for the salvation of the Goryeo people during the Mongol occupation. Others speculate that it was commissioned to pray for the birth of a child.

SLIDE 4



The Bodhisattva Kshitigarbha, 1300–1390
Hanging Scroll, ink, colors, and gold on silk
Nezu Institute of Fine Arts, Japan

WHO IS KSHITIGARBHA?

Kshitigarbha is a bodhisattva who delivers souls of the dead who are suffering in hell to the Buddha Amitabha's Pure Land paradise. Unlike Amitabha and the bodhisattva Avalokiteshvara, who provided salvation for those on earth, Kshitigarbha was worshiped to bring salvation for the already deceased.

Devotees believed that the fate of a person's soul was determined by the Ten Kings who ruled Buddhist purgatory. The soul would pass through the different courts of the Ten Kings over a period of three years. Living relatives of the deceased performed rituals to help earn a favorable judgment, and Kshitigarbha was known to intercede on their behalf.

WHAT ARE THE CHARACTERISTICS OF KSHITIGARBHA?

In Goryeo dynasty paintings, Kshitigarbha is depicted with a bandana-like scarf over his head, a staff in his left hand, and a jewel in his right hand, which is said to illuminate even the darkest corners of hell.

SLIDE 5



Miniature shrine, 1300–1390
Gilded bronze
National Museum of Korea, D2115

WHAT IS THIS OBJECT?

This portable shrine is shaped like the main hall of a typical Buddhist monastery. Opening the two main doors reveals a scene of the buddha Amitabha flanked by two bodhisattvas and several disciples. The images on the door are those of Two Benevolent Kings. Although it is not visible in this image, the exterior side walls contain images of the Four Heavenly Kings, two on each side, with eight lesser deities on the rear wall. As with other portable shrines from the time period, it is believed that there would have been two figures (now missing) placed within the center of the shrine. A portable shrine like this one would have been used in Buddhist rituals.

SLIDE 6



Flower Garland Sutra, vol. 78, 1000--1100
Woodblock prints mounted on a handscroll, ink on paper
Ho-Am Art Museum, Korea

WHAT IS A SUTRA?

A sutra is a record of the teachings of the Buddha. This woodblock print (mounted as a handscroll) is a version of the Flower Garland Sutra (Korean: Hwaeum-gyeong; Sanskrit: Avatamsaka Sutra). Some believe that this sutra was first taught by the Buddha in the second week after his enlightenment, while he still sat below the Bodhi tree. Associated with the buddha Vairochana, it describes all aspects of reality as united. An enlightened being can move freely between worlds, because he realizes that everything arises from the mind.

WHY WAS IT IMPORTANT TO WRITE OR COMMISSION SUTRAS IN THE GORYEO DYNASTY?

The writing and commissioning sutras were considered to be meritorious acts. The creation of the woodblocks from which this sutra was printed was prompted by the frequent invasions by neighboring countries. The carving of was intended as a prayer to the Buddha for the expulsion of the foreign invaders.

WHY IS THIS PARTICULAR PRINT OF THE SUTRA SO IMPORTANT?

One of the most spectacular achievements of the Goryeo dynasty was the carving of the Tripitaka, the entire Buddhist canon (sutras, laws, and treatises), not once but twice. Both sets were created in an effort to stem foreign invasions and protect the nation. With the Goryeo court eager to expel the invading Khitans, the first set was completed in 1087, but it was destroyed by fire during the Mongol invasions in 1232. A second set was begun in 1236 on Ganghwa Island, where the court was taking refuge during the Mongol occupation. This second set, comprising more than eighty thousand woodblocks, was completed sixteen years later, in 1251, and is now housed in Haeinsa Monastery.

This print is one of the rare surviving copies of the first carving of the Tripitaka.

WHY IS THE SUTRA WRITTEN WITH CHINESE CHARACTERS IF IT WAS CREATED IN KOREA?

This sutra was carved before the current Korean writing system was created. Before the invention of *Hangeul*, the Korean phonetic alphabet, Chinese characters were used as the primary writing system in Korea. In 1446, under the reign of King Sejong, Hangeul was developed. This alphabet, containing twenty-four characters, is used to this day.

SLIDE 7



Flower Garland Sutra, vol. 12, approx. 1350
Frontispiece in gold and silver text on indigo blue paper
Ho-Am Art Museum, Korea

WHAT DOES THIS SUTRA ILLUSTRATE?

In the center of the frontispiece of this version of the Flower Garland (Korean: Hwaeum-gyeong; Sanskrit: Avatamsaka Sutra) is an image of the buddha Vairochana preaching. He is making the “wisdom fist” gesture, his right hand holding the index finger of his left. The buddha is flanked by two bodhisattvas, Manjushri (Korean: Munsu) and Samantabhadra (Korean: Bohyeon), and an assembly of bodhisattvas and two royal figures.

WHAT IS AN ILLUMINATED SUTRA?

Similar to Goryeo Buddhist paintings, illuminated sutras were commissioned by the royalty, aristocrats, and Buddhist priests to pray for a variety of good outcomes—including safety of the nation, the birth of many children, recovery from illness—or as tributes to their ancestors.

Illuminated sutras were created using mulberry paper, which was dyed purple, dark blue, ochre, or yellow and then beaten until the surface produced a shiny surface suitable for writing and painting. These texts and illustrations were written in gold or silver by well-trained scribes and painters who worked in scriptoria maintained by the court and major temples. As in this example, the frontispiece (first section) of illuminated sutras often shows a preaching buddha surrounded by attendant figures.

The Flower Garland Sutra was one of many scriptures that were copied into an illuminated manuscript format. Other popular sutras included the Lotus Sutra (Korean: Myobeop Yeonghwa-gyeong; Sanskrit: Sadharma Pundarika Sutra) and the Diamond Sutra (Korean: Geumgang-geyong; Sanskrit: Vajracchedika prajaparamita). The Lotus Sutra, which was the most important scripture of the Three Kingdoms period, views the Buddha as ever present, and states that salvation is possible for all beings. The Diamond Sutra explains the doctrine of emptiness (*shunyata*) and wisdom (*prajna*), a principal text of the Seon (meditation) school of Korean Buddhism.

SLIDE 8



Incense burner, 1229
Bronze with silver inlay
Ho-Am Art Museum, Korea, National Treasure no. 214

WHAT IS THIS OBJECT?

This incense burner was used in Buddhist rituals to burn incense in front of an altar. This stemmed bowl (*hyangwan*) is an example of the most common form of Goryeo dynasty incense burner. This particular object is considered a masterpiece and is listed as a Korean National Treasure. According to the inscription on the foot of the burner, this object was commissioned by the monks of the Heung-wang-sa Monastery in Gaeseong and the deputy officer of Jillye-gun in South Chungcheong province.

WHY WAS INCENSE USED IN BUDDHIST CEREMONIES?

Incense is used in many religious contexts around the world. In addition to its religious function, incense also helped to keep insects at bay and to perfume the air. This was especially important, given the fact that Buddhist institutions presided over cremations and other funerary rituals.

WHAT DESIGNS DO YOU SEE ON THE SIDE?

This incense burner is decorated with several motifs. The two phoenixes hold lotus stems in their mouths, while the dragon holds a precious jewel. Other designs include scenes of water reeds, lotus flowers and ducks. Goryeo dynasty ritual vessels were often decorated with such popular motifs as flowers, dragons, phoenixes, clouds, and lotuses.

SLIDE 9



Ritual sprinkler (*kundika*), 1300–1400
Bronze with silver inlay
Asian Art Museum, Gift of Namkoong Ryon, 1991.147

WHAT IS A KUNDIKA?

One of several Buddhist ritual objects that originated in India and were introduced to Korea with Buddhism, the kundika is used in Buddhist ceremonies to sprinkle sacred water for purification. In Korea this water is believed to have the power to quench thirst and to ease the sufferings of all living creatures. Water is poured into a kundika through the spout located on the side of the main body. During a ritual, the water is sprinkled from the tall thin spout on the top.

The popularity of Buddhism during the Goryeo dynasty led to the production of a great number of kundika both in metal and ceramic forms. Kundika appear in numerous Buddhist paintings, often in the hand of the bodhisattva Avalokiteshvara. This kundika is made of bronze with silver inlay and is decorated with a tranquil scene of large trees, water plants, ducks swimming in a pond, and geese flying.

SLIDE 10



Vase, 1100–1200
Stoneware with inlaid design under celadon glaze
Tokyo National Museum, TG-2171

WHAT IS CELADON?

Celadon refers to stoneware with a pale green glaze. Initially inspired by Chinese *yue* ware, Goryeo dynasty potters rapidly developed their own technique, which resulted in a uniquely Korean art form. The first Korean celadons were probably produced in the late ninth century (though this date is currently a subject of much debate), and the art form reached its pinnacle during the first half of the twelfth century.

WHAT KINDS OF OBJECTS WERE MADE?

Celadons were produced for a wide variety of uses. Ritual water sprinklers (*kundika*), ewers, incense burners, and special lotus-shaped bowls were produced for Buddhist ceremonies while teacups, bottles, bowls, water droppers, pillows, boxes, and vases were produced for use in the homes of the royalty and aristocracy. The object featured here is a prunus vase (Korean: *maebyeong*), so called because it was probably used to hold a single flowering branch of a plum (*Prunus*) tree. This type of vase is characterized by a small mouth, short neck, round shoulder, and narrowing waist.

WHAT DESIGNS DO YOU SEE ON THE VASE? WHERE HAVE YOU SEEN THESE BEFORE?

The scene on the vase is a tranquil landscape with water birds, butterflies, bamboo, and a flowering plum tree. Objects in previous slides, such as the incense burner and the *kundika*, depict similar idyllic scenes.

SLIDE 11



Ewer with bowl, 1150–1200
Stoneware with inlaid and copper-oxide design under celadon glaze
National Museum of Korea, D19 and D26

WHAT IS A EWER?

A ewer is a vessel with a handle and a spout used for pouring liquids such as wine or water. Inspired by nature, Goryeo dynasty ewers were produced in a wide variety of shapes such as animals, melons, and gourds. This example is in the form of a gourd and is accompanied by a matching bowl. In order to keep wine warm, this ewer is designed to rest inside the deep bowl, which would be filled with hot water.

HOW WERE THE DESIGNS INCORPORATED IN THE SURFACE OF THE VASE?

This ewer and bowl set and the vase in the previous slide were decorated using the inlay technique. In this process, patterns are carved out of the surface of the leather-hard clay, then filled with either white or red slip (a watery clay mixture). When the vessel is fired, the white stays white while the red turns black. Although the inlay technique was used for both objects, the ewer and bowl set underwent an additional step to achieve the unique color of the grapes. After an initial firing, copper oxide was applied to the grapes. The set was then covered with celadon glaze and fired a second time, resulting in the vibrant red color of the grapes.



Lesson Plans and Activities

Lotus Lantern Festival

Elementary through High School

Written and illustrated by Stephanie Kao

SUBJECT AREA:

History-Social Sciences and Visual Arts

OBJECTIVES:

Students will

- learn that Buddhism is a religion founded by an enlightened young Indian prince who became the Buddha.
- learn how the Buddha's birthday, a national holiday, is celebrated in Korea.
- discuss how the lotus flower is symbol of purity and wisdom.
- construct a lotus blossom lantern.

MATERIALS:

Poster board, pink and green crepe paper, white paper, lantern frame stencil, lotus petal stencil, pencil, markers, wire, scissors, hole punch, and tape (preferably Scotch transparent tape). Alternatively, the lantern

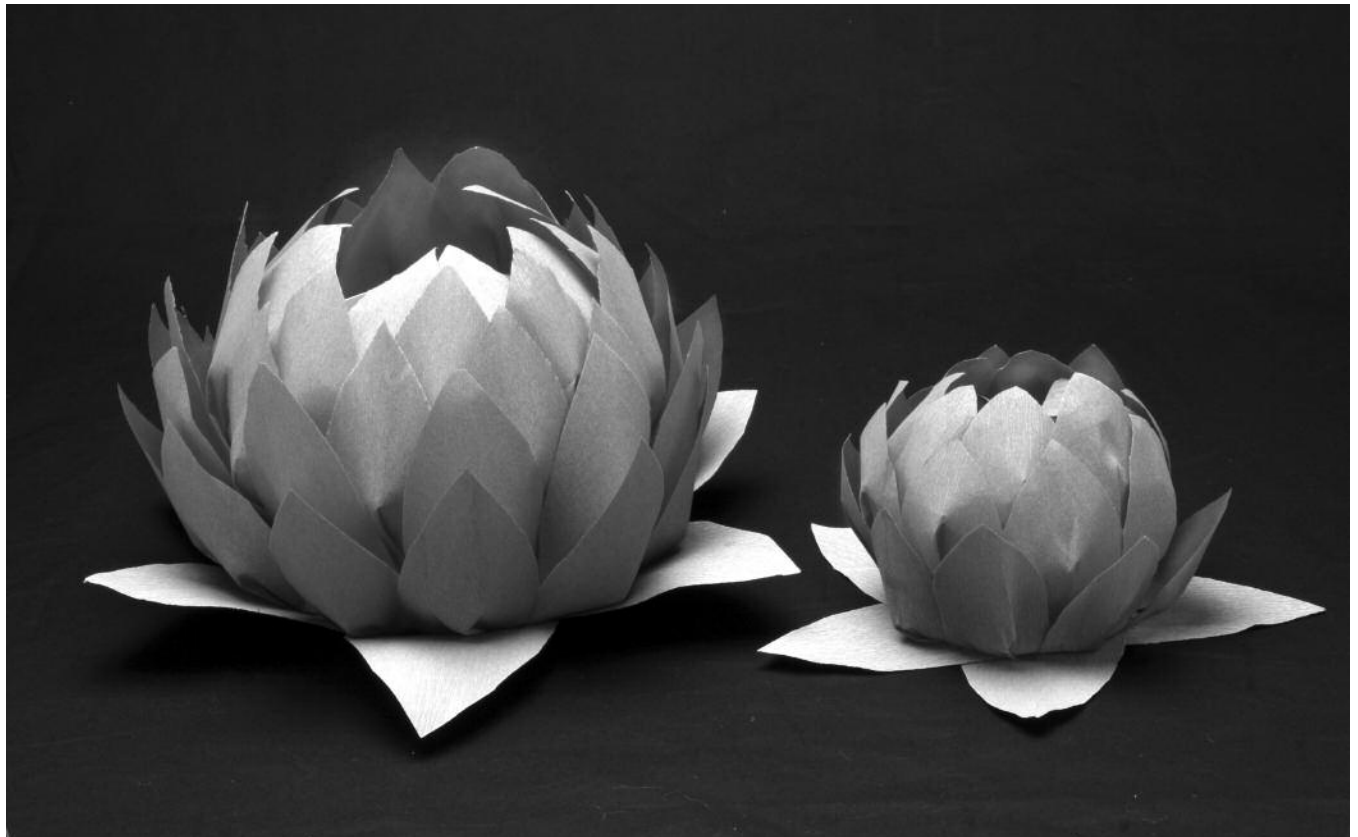

Lotus lanterns are unique to Korea and are made in celebration of the Buddha's birthday. Photo by Kaz Tsuruta.

frame can be made using a large tissue box, ruler, and compass.

SUGGESTED RESOURCES FOR TEACHERS:

Buswell Jr., Robert E., *The Zen Monastic Experience: Buddhist Practice in Contemporary Korea*. New Jersey: Princeton Press, 1992.

Korean Buddhist Chogye Order, *What is Korean Buddhism?* Seoul: Korean Buddhist Chogye Order, 2002.

SUGGESTED WEBSITES FOR STUDENTS:

Buddha's Birthday Celebration Committee, in *Lotus Lantern Festival (updated 2003)*
<http://www.llf.or.kr/eng/>

Todd Thacker, "Enlightened Tradition," in *Korea Now: Biweekly Magazine*, Sept. 2003
http://kn.koreaherald.co.kr/SITE/data/html_dir/2002/06/07/200206070036.asp#top

DESCRIPTION:

The Lotus Lantern Festival, also known as Yeondeunghoe or the "Feast of Lanterns," is one of the most celebrated Buddhist ceremonies held in Korea. On the eighth day of the fourth lunar month (late April or early May of the Roman calendar), hundreds of thousands of candlelit paper lanterns are raised throughout the country to commemorate the Buddha's birthday. In addition to the popular eight-sided lantern painted with Buddhist symbols of longevity and good fortune, lanterns are also constructed in various shapes and sizes based on themes of birth—including turtles, watermelon, fish, and ducks. These decorative lanterns are suspended in the front of every household, one lantern for each family member, with their names and prayers written on narrow sheets of white paper that sway gently from the base of the lanterns.

The tradition of celebrating the Buddha's birthday in conjunction with the lantern festival dates to the Goryeo dynasty. This ceremony, which became a Korean national holiday in 1975, honors the great teachings of a young Indian prince named Siddhartha Gautama, who lived nearly 2,500 years ago and gave up his royal life in search of a way to end suffering in the world. After years of searching, the prince found enlightenment, or perfect understanding, and became the Buddha, which means the "Enlightened One."

In Korean Buddhist temples, preparation for this special day begins one week before the event. During this time, monks carefully repair lanterns used in the previous year's festivities while also creating new decorative ones. The most cherished type of lantern made by the monks is the delicately crafted lotus lantern. The lotus flower, a symbol of purity and wisdom, holds special significance in the Buddhist tradition. The flower, whose strong roots allow it to rise from the mud and blossom with great beauty, represents the individual who overcomes greed and hatred to find enlightenment.

On the morning of the Buddha's birthday, monks begin stringing row upon row of lanterns to adorn pathways surrounding the temple. The lanterns hang along the walkways of the inner courtyards. The monks then sweep the temple grounds in expectation of the arrival of the public, who are invited on this day to tour the monastery. When visitors arrive, they are invited to purchase a lantern and follow the Buddhist tradition of asking a monk to write a merit certificate in honor of a visitor's family members and/or deceased relatives. The monk writes the family names in calligraphy on the certificate and pastes it so that it hangs from bottom of the lantern. This offering to the Buddha is said to contribute to the good fortune of the family. In the evening, family members return to the temple to light their lanterns, light incense, and pray. The culmination of the event occurs as chanting monks light the candles one at a time in each of the

remaining lanterns to illuminate the temple.

PROCEDURE:

Locate Korea on a map. Introduce a general history of the life of Indian prince Siddhartha Gautama, who became the Buddha. Discuss with students how the teachings of the Buddha spread from India through Central Asia and China; and how these teachings arrived in Korea in 372 CE. Explain how the Buddha's birthday is celebrated in Korea. Have students research the Lotus Lantern Festival using the internet. Discuss the symbolism of the lotus flower in Buddhism. Compare and contrast this ceremony to those celebrated in the United States.

ACTIVITY:

1. Using a pencil, trace the lantern frame stencil twice on the poster board. Cut out the shapes with scissors, and tape them together to form a row of eight connected panels. (Please note that the stencil provided needs to be enlarged 200 percent.)

An alternate method for making a lantern frame is to use a large tissue box as described below (see illustration):

- a. Cut open one large tissue box lengthwise.
- b. Place the lantern frame stencil on top of the tissue box. Trace the stencil twice, one tracing directly above the other.
- c. Cut out the shapes and tape them together to form a row of eight connected panels. Each panel should be octagonal. See the dimensions below.

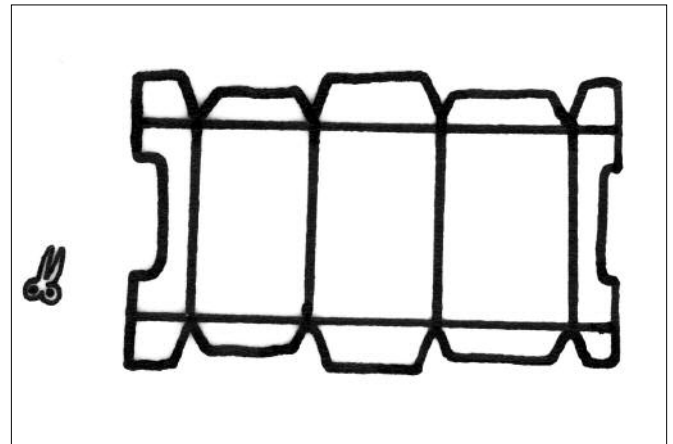
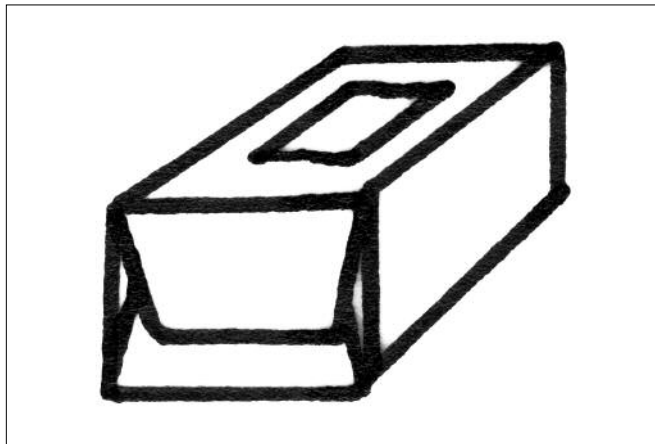

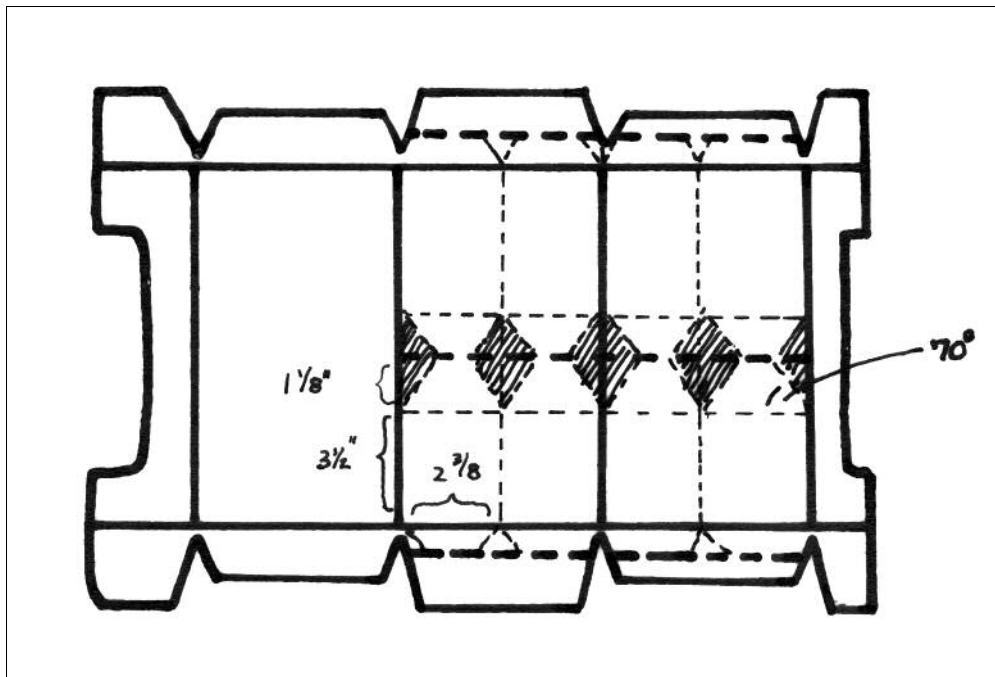

2. Tape the ends of the row of panels together so that they form a cylinder. At the bottom and top of the cylinder, gently fold the top and bottom of each octagonal panel over at an angle and tape together. The frame should now have the appearance of a small ball.
3. Fold the pink crepe paper along the grain of the paper. Using the lotus petal stencil, draw and cut out petals for the lantern. Gently fold over and pinch the bottom of each petal to give it a concave shape.
4. Starting from the top, tape rows of pinched paper petals onto the frame until it is covered.
5. Next, cut the green crepe paper along the grain to form five large petals (slightly larger than the lotus petals) and tape them to the bottom of the frame. Using the hole punch, make two holes on opposite sides at the top of the frame. Tie a wire through the holes to create a hanger for the lantern. Using markers on a small rectangular piece of white paper, have students write their wishes and the names of their immediate family members and/or deceased relatives. Finally, tape this paper to the bottom of the lantern so it dangles when the lantern hangs.

LOTUS LANTERN ACTIVITY



Lotus lanterns. Photo by Kaz Tsuruta.

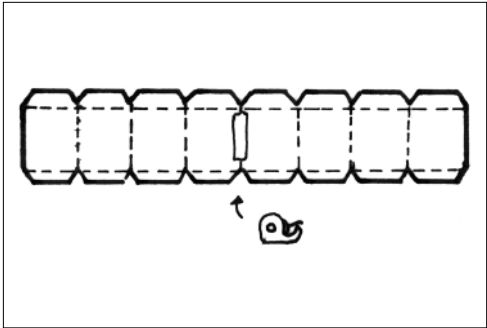

1

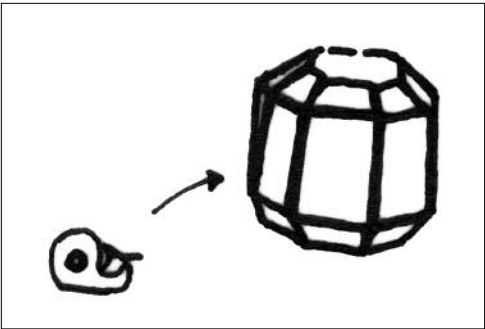

2

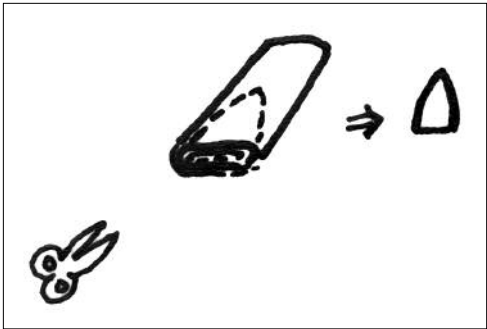

3

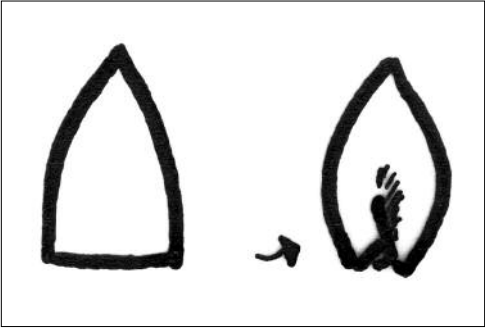

4

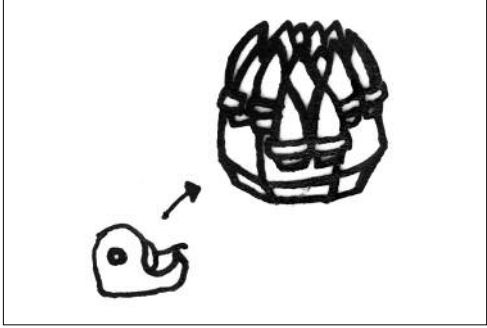

5

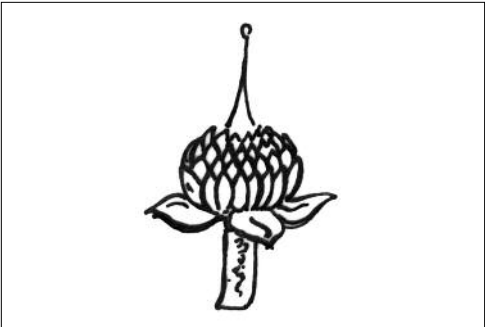

6

Mini-Lotus Lanterns

Elementary through High School

Lesson written and illustrated by Stephanie Kao

Please refer to the lesson plan Lotus Lantern Festival in this packet for a description of the festival, lesson objectives, procedure, and further student resources.

MATERIALS:

Two empty half-pint containers, pink and green crepe paper, white paper, small petal stencil, pencil, markers, wire, scissors, pushpins, flathead pins, and tape (preferably Scotch transparent tape).

ACTIVITY:

1. Using a pushpin, punch a large hole in the bottom of an empty half-pint container. Tie a knot at the end of a wire. String it through the hole so that the container can be hung upside down.
2. Tape the top of one container to the top of another empty half-pint container so that it is secure.
3. Fold the pink crepe paper along the grain of the paper. Using the small lotus petal stencil, draw and cut out petals for the lantern. Gently fold over and pinch the bottom of each petal to give it a concave shape. (Please note the stencil provided in this packet needs to be enlarged 200 percent).
4. Starting from the top, tape rows of pinched paper petals onto the frame until it is covered. In order to secure the petals to the bottom of the containers, you may need to reinforce them with small flathead pins. Teachers and parents may need to help younger students do this.
5. Next, cut the green crepe paper along the grain to form five large petals (slightly larger than the lotus petals) and tape them to the bottom of the frame. Using markers on a small rectangular white piece of paper, have students write their wishes and the names of their immediate family members and/or deceased relatives. Finally, tape this paper to the bottom of the lantern so it dangles when the lantern hangs.

MINI-LOTUS LANTERN ACTIVITY



Lotus lanterns. Photo by Kaz Tsuruta.

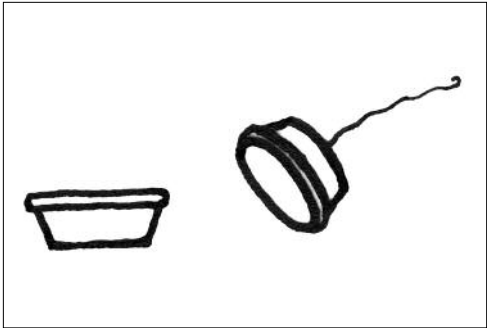

1

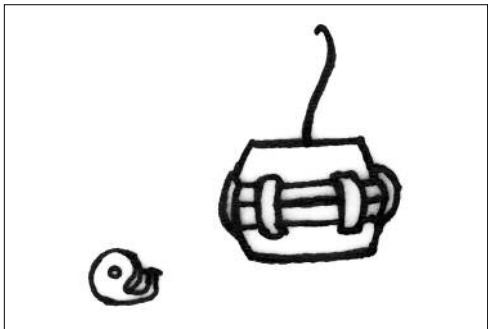

2

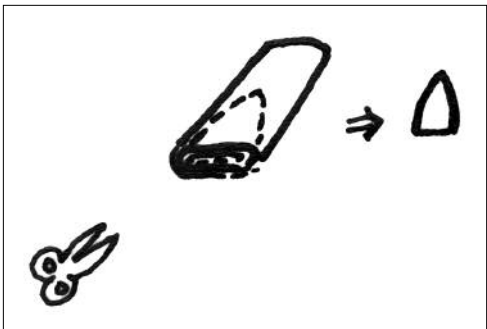

3

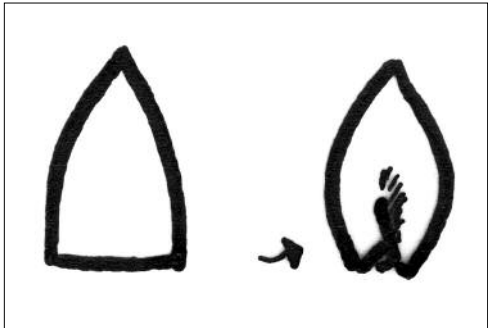

4



5

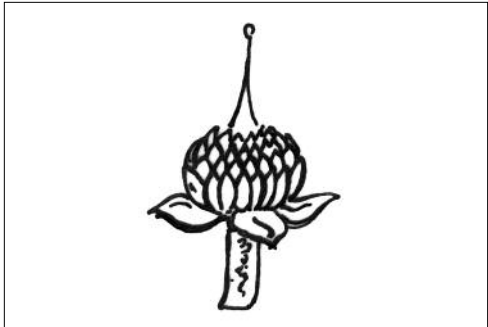

6

LOTUS LANTERN STENCILS

Please note that all stencils need to be enlarged by 200 percent.

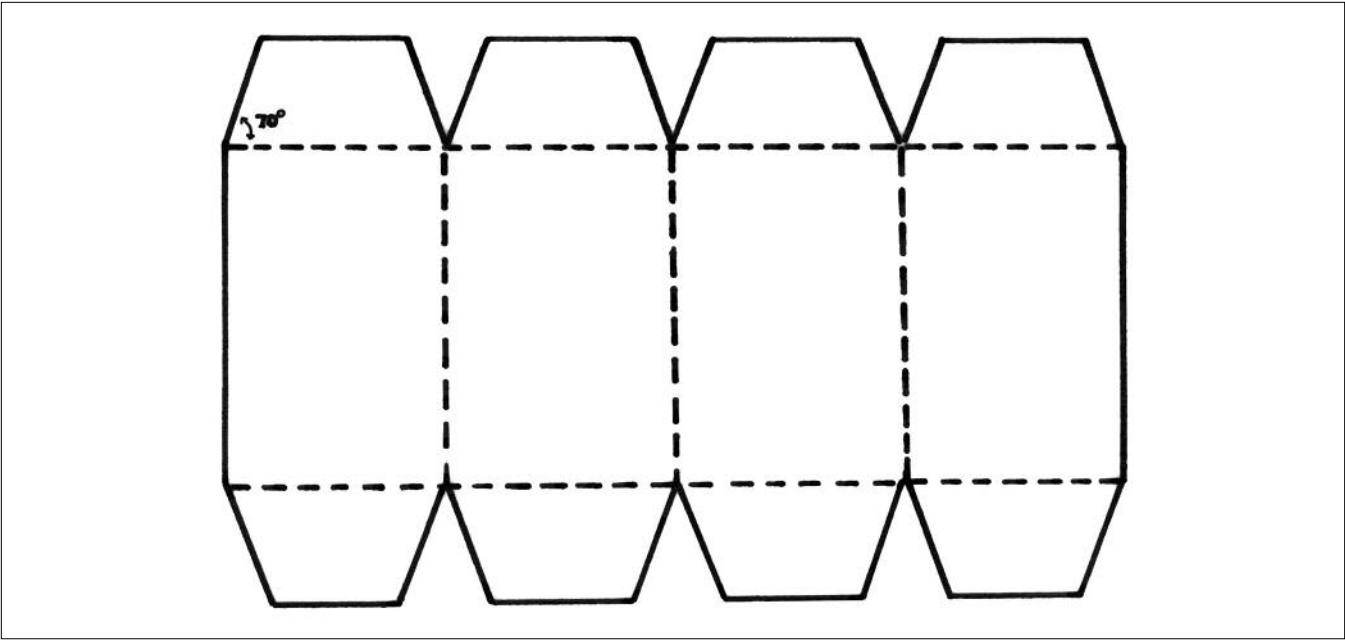

lotus lantern frame

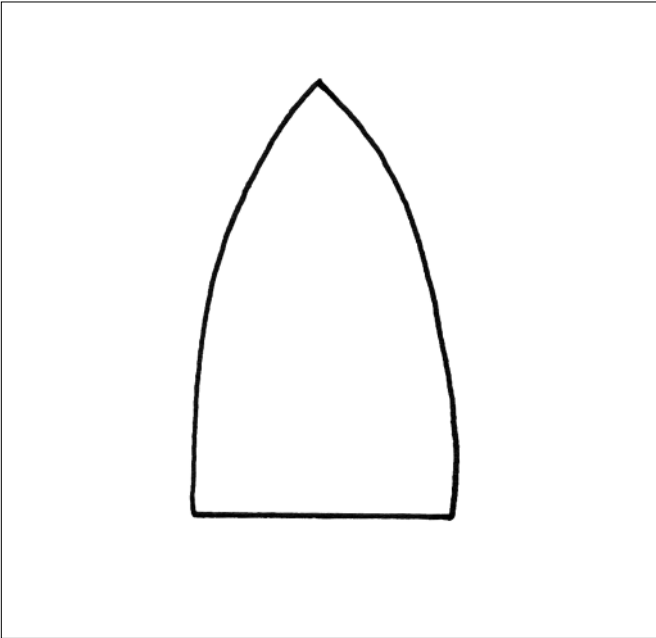

lotus petal

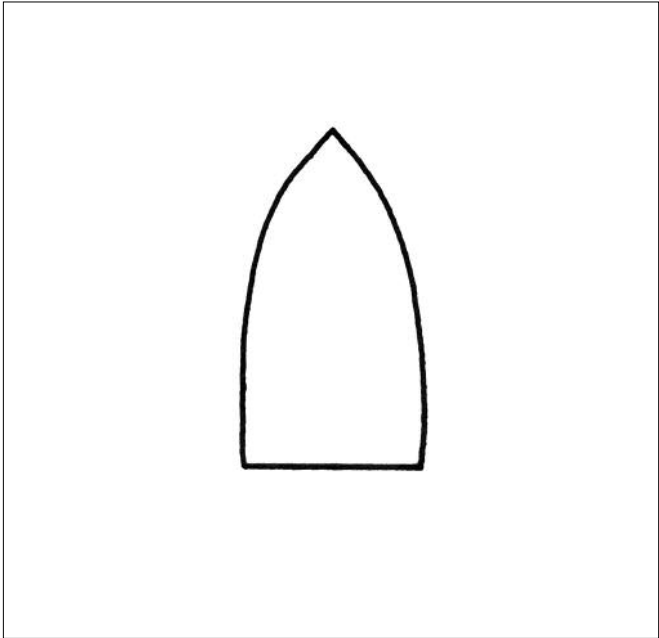

mini-lotus petal

Illuminated Manuscripts: The Sacred Art of Narration

Middle through High School

Lesson written and illustrated by Stephanie Kao

SUBJECT AREA:

History-Social Sciences, Language Arts, and Visual Arts

OBJECTIVES:

Students will

- identify the format and elements of a sutra.
- examine why sutras are important historical and religious documents.
- analyze why the writing of sutras is considered an important religious act.
- construct and illustrate an accordion book manuscript based on the sutra format used during the Goryeo dynasty.

MATERIALS:

Indigo blue paper, poster board, gel pens, fine point liquid gold and silver markers, worksheet of Buddhist motifs, scissors, glue, and ruler.

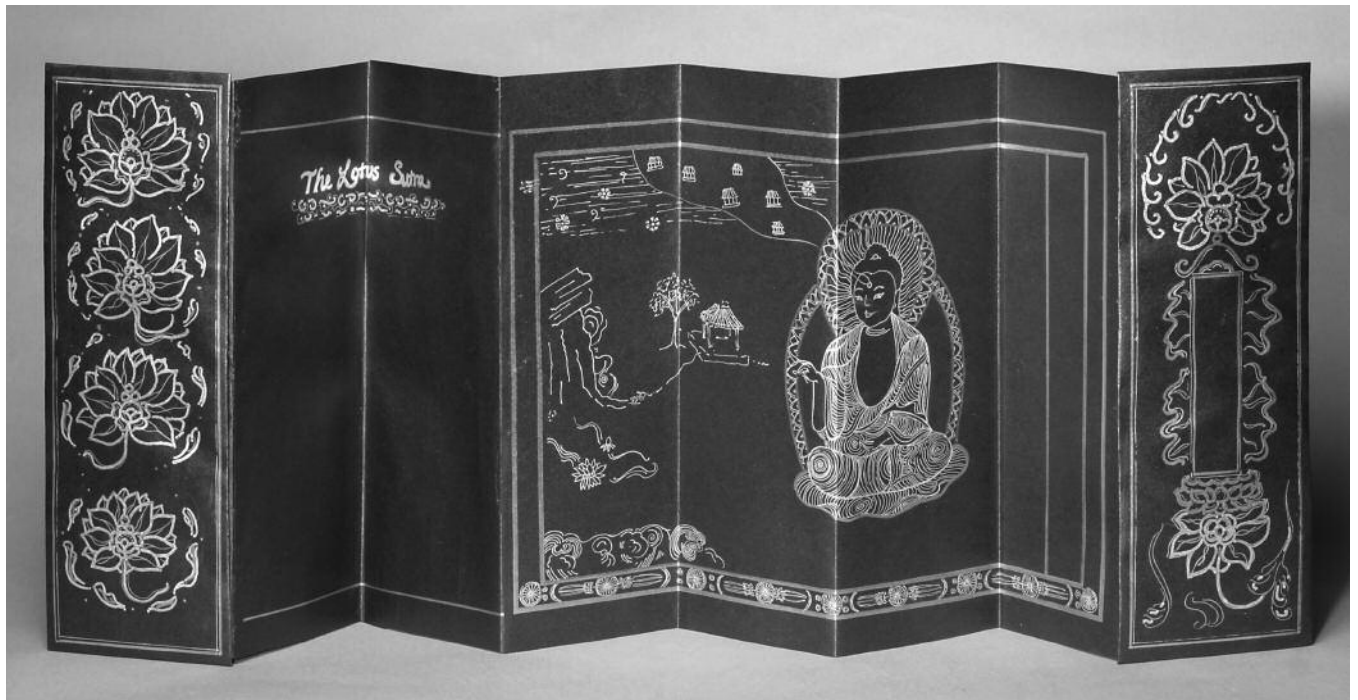

Create your own illuminated manuscript with gel pens and gold liquid makers. Photo by Kaz Tsuruta.

SUGGESTED RESOURCES FOR TEACHERS:

Pak, Youngsook, "Goryeo Illuminated Buddhist Scriptures: Transmission of Text and Images," in *Goryeo Dynasty: Korea's Age of Enlightenment (918–1392)*, ed. Tom Christensen (San Francisco: New Asian Press, 2003), 96–105.

Korean Buddhist Chogye Order, *What is Korean Buddhism?* (Seoul: Korean Buddhist Chogye Order, 2002).

DESCRIPTION:

The religious fervor and opulence of the Goryeo dynasty can be seen in the intricately hand-copied sutras (the teachings of the Buddha) that date to this period. Korean monk-scribes were commissioned by royals, aristocrats, and individual high-ranking monks to write the sacred words of the Buddha by applying pigments of ground gold and silver to deep indigo-dyed mulberry paper. They began by pictorially narrating the sermons of the Buddha with key episodes within the sutra chapter on the frontispiece (first four sutra panels). The rest of the sutra comprised flowing calligraphy translating the Buddha's teachings.

Monk-scribes, and in later times professional calligraphers, working in a royal scriptorium followed strict rules when writing a sutra, which is composed of set elements within a structured format. One format in which a sutra may be copied is the accordion booklet, a long rectangular book with one long sheet of paper folded back and forth inside like an accordion. Traditionally, the interior paper is made of several sheets pasted together. The front and back of the booklet are often decorated with mythical flowers called *bosanghwa*. In the center of the booklet cover is a vertical rectangle known as a cartouche, within which the title is written.

A sutra is read from right to left, beginning with the frontispiece. At the upper-right-hand corner of the frontispiece is the sutra title. Sutras of the early 1300s often have the figure of the Buddha accompanied by his attendants painted in the right half of the frontispiece. Key events within the sutra are shown on the left half. The entire space is filled with decorative lines, spirals, dots, other abstract geometric designs, and Buddhist motifs. A border outlining the frontispiece is made up of the thunderbolt (*vajra*), symbolizing wisdom, and the wheel of the Doctrine (*chakra*), symbolizing Buddhist teachings, in repeating patterns. Written from right to left, the pages that follow the frontispiece contain the sutra text, those commissioned by royalty having fourteen characters per line. At the end of the sutra is a dedicatory inscription. It is in this section that the date, the donor's name, the name of individual for whom the sutra is dedicated, a prayer, and the name of the monk-scribe is written.

Although a form of movable metal type was invented in Korea in the twelfth century to allow for the mass production of Buddhist texts, laboriously hand-copied illuminated sutras continued to be commissioned. This is because the act of writing Buddhist scriptures was considered the deepest expression of Buddhist worship, bringing religious merit to the monk-scribe, the patron, and the family members and/or deceased relatives to whom the writing was dedicated.

PROCEDURE:

Introduce Buddhism and its influence on Korea's Goryeo dynasty. Ask students why individuals would want to commission a sutra. You may want to discuss with students how Goryeo rulers believed that by worshiping the Buddha, the nation would be protected from foreign invasion. Discuss why hand-copied

sutras were considered religious acts. Have students identify the format of a sutra and the materials used to make one. Have students compare and contrast the tradition of Korean Buddhist illumination with that of Christian illumination from Europe's medieval period.

ACTIVITY:

1. Select a short story that holds special meaning for you. Write down the key events that take place in the short story. Draw thumbnail sketches of how you would illustrate and compose these events in a compact manner. Cut out two 12 1/4" x 4 1/4" rectangles of poster board.
2. Cut out two 13 1/4" x 5 1/4" rectangles of blue paper. Lay down, center, and glue each poster board rectangle on top of a piece of blue paper. Cut off the corners at an angle.
3. Glue the flaps of blue paper over the sides of each poster board rectangle. These will be the cover and back of your sutra booklet.
4. Cut out a 12" x 34" rectangle of blue paper. If you do not have paper this length, small rectangles (12" x 5 1/4"—the size of one sutra panel with a little extra to glue to the neighboring panel) may be cut and glued together.
5. Fold the long blue paper rectangle back and forth like an accordion. Next, glue the cover and back of the booklet to either end. Notice that when the sutra is laid flat, you should be able to see the cover and back of the booklet.
6. Using a pencil, lightly sketch out decorative designs on the cover and back of the booklet. Write the title of the short story on the front cover. Next, draw a decorative border around the first four panels (starting from right to left). This forms the border of the frontispiece. Using pencil, roughly sketch key scenes from your short story. On the remaining panels, write a summary of the short story in decorative lettering. Using gel pens and gold and silver liquid markers, draw over your sketches making corrections as necessary. Feel free to decorate the entire frontispiece panels with abstract designs. Use the worksheet "Buddhist Motifs and Designs" for ideas.

Illuminated Manuscripts: The Sacred Art of Narration

ACTIVITY INSTRUCTIONS:



Example of illuminated manuscript.
Photo by Kaz Tsuruta.

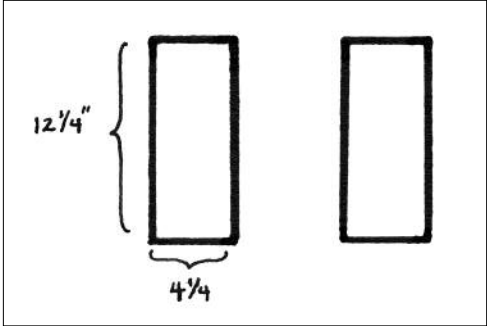

1

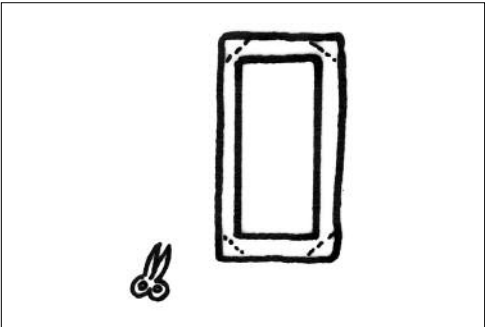

2

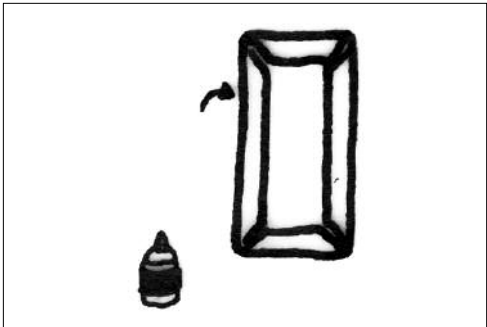

3

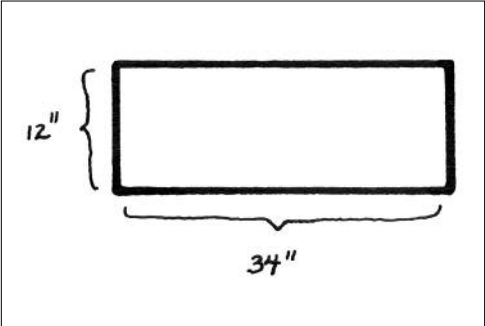

4

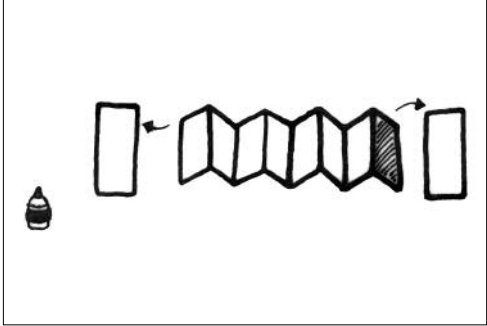

5

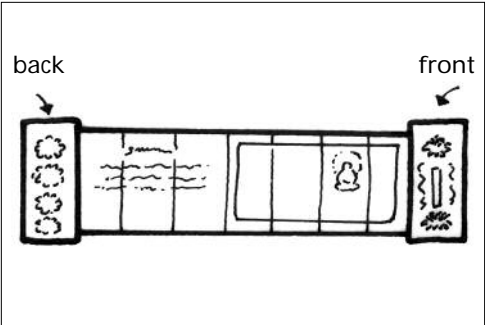

6

BUDDHIST MOTIFS AND DESIGNS



Bosanghwa (heavenly flower)

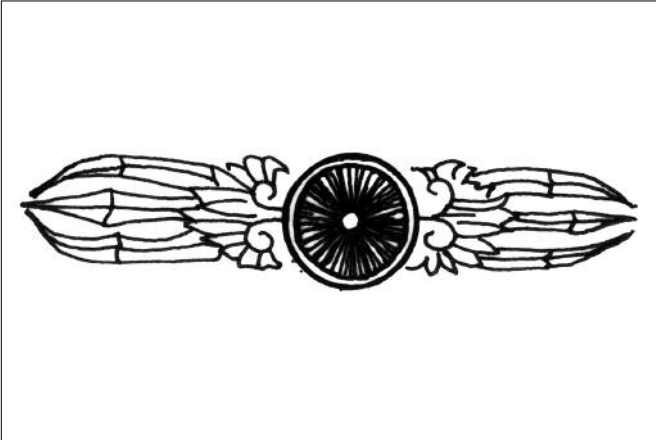

Buddhist thunderbolt (*vajra*) and wheel of the Doctrine (*chakra*).



Sky filled with heavenly flowers and swirling ribbons



Flower-filled sky and mushroom shaped clouds



Bibliography

Bibliography

BOOKS

Korean Cultural Heritage: Fine Arts. Seoul: Korea Foundation / Yeong and Yeong, 1996.

Korean Cultural Heritage Seen through Pictures and Names, vols 1 and 2. Seoul: Time and Space Tech, 2002.

Kim, Kumja Paik. *Goryeo Dynasty: Korea's Age of Enlightenment (918–1392)*. San Francisco: Asian Art Museum, 2003.

Lancaster, Lewis, Kikun Suh and Chai-shin Yu, eds. *Buddhism in Koryo: A Royal Religion*. Fremont, CA: Asian Humanities Press, 2002.

Lee, Peter H., and William Theodore de Bary, eds. *Sources of Korean Tradition, vol. 1: From Early Times through the Sixteenth Century*. New York: Columbia University Press, 1997.

Pak, Youngsook. *Handbook of Korean Art: Buddhist Sculpture*. Seoul: Yekyong, 2002.

_____. *Handbook of Korean Art: Earthen-ware and Celadon*. Seoul: Yekyong, 2002.

Portal, Jane. *Korea: Art and Archaeology*. London: Thames and Hudson, 2000.

Smith, Judith G., ed. *The Arts of Korea*. New York: Metropolitan Museum of Art, 1998.

TEACHING PACKETS

Temple, Palace, Scholar's House: Three Settings of Traditional Korean Culture. San Francisco: Asian Art Museum, 2000.

Hammer, Elizabeth, and Judith G. Smith, eds. *Arts of Korea: A Resource for Educators*. New York: Metropolitan Museum of Art, 2002.

VIDEO

Reviving the Art of Goryeo Dynasty Celadons. San Francisco: Asian Art Museum, 2003. (Available early November 2003.)



Timeline



Map of Korea

